

**Are you ready for professional dry aging?  
Perfect - get started with DRY AGER®!**

<b>Table of Contents</b>	<b>Page</b>
<b>Dry Aging</b>	2
<b>Safety Instructions and Warnings</b>	3
<b>Climate rating</b>	4
<b>Saving Energy</b>	4
<b>Electrical Safety</b>	4
<b>Disposal notes</b>	4
<b>Range of Appliance Use</b>	4
<b>Noise emission</b>	4
<b>Quick Starter Tips</b>	5
<b>Dimensions</b>	6
<b>Integrated systems</b>	6
<b>Description of the Appliance</b>	6
<b>Integration drawing</b>	7
<b>Instruction for unpacking</b>	7
<b>Setting up the appliance</b>	7
<b>Preparing the device</b>	7
<b>Operating the Appliance</b>	8
Overview of Control Panel	8
Controller Keys	8
Controller Key Combinations	8
Controller Display and Symbols	8
<b>Starting the Operation</b>	9
Electrical connection	9
Switching the appliance ON	9
Turning the interior light ON/OFF	9
Turning the UVC disinfection ON	9
Choosing temperature & humidity setpoint	9
Setting temperature	9
Setting humidity	9
Locking and unlocking keypad	9
Locking and unlocking door	9
<b>Loading the Device with Food</b>	10
Select food	10
Wait for temperature setpoint to be reached	10
Fill the device	10
Consider aging time	11
<b>During Device Operation</b>	11
<b>Shutting Appliance down</b>	11
<b>Cleaning Instructions</b>	12
Preparation for the cleaning procedure	12
Cleaning the accessories	12
Cleaning the appliance interior	12
Cleaning the outside of the appliance	12
<b>Troubleshooting</b>	12
<b>Error Messages</b>	13
<b>Maintenance</b>	13
<b>Customer Service</b>	13
<b>Appliance Information</b>	13
<b>Disclaimer</b>	13
<b>DX Remote Control</b>	14

## Dry Aging

No more secrets about dry aging, from now on you can produce the best tasting meat in the world at home, with your DRY AGER Vision 360°.

Dry aging produces a very good meat quality full of character and the naturally harmonious taste of the meat is emphasised.

The result is literally a whole bouquet of aromas. The matured meat is characterised by a pleasant, firm structure, is nicely tender and has the perfect bite. When roasting or grilling dry aging meat, hardly any moisture/liquid escapes and the taste-fully spicy fat edge creates a particularly intensive aroma.

### The meat quality

The best results in terms of taste are achieved when maturing on the bone.

Age and gender, as well as breed and husbandry conditions of the animals are decisive for your dry ripening results. Freshly slaughtered meat from heifers, young female cattle is best suited. The meat becomes very tender, as it has a handsome fat cover and a very high intramuscular fat content.

It is always recommended to let whole back strands mature in a hanging position or parts of them lying down. The maturing period should last at least 21 days, after which the maximum tenderness of the meat is reached. If the meat is matured for a longer period of time in the following days, only the taste will develop further.

Please note: A maturing period of up to 10 weeks is possible. Always ensure that the meat is handled hygienically, this is a basic requirement for perfect results. After the maturing process is complete, the dark and dry areas must be removed generously.

### We wish you much joy and pleasure with Dry Aging. Founder of the DRY AGER® Manufacture

Christian, Aaron, Andreas & Manfred Landig

# Safety Instructions and Warnings

- To prevent injury or damage to the unit, the appliance should be unpacked and set up by two people.
- In the event that the appliance is damaged on delivery, contact the supplier immediately before connecting to the mains.
- To guarantee safe operation, ensure that the appliance is set up and connected as described in these operating instructions.
- Disconnect the appliance from the mains if any fault occurs. Pull out the plug or switch off or unscrew the fuse.
- When disconnecting the appliance, pull on the plug, not on the cable.
- Any repairs and work on the appliance should only be carried out by the customer service department, as unauthorised work could prove highly dangerous for the user. The same applies to changing the mains power cable.
- Do not allow naked flames or ignition sources to enter the appliance. When transporting and cleaning the appliance, ensure that the refrigerant circuit is not damaged. In the event of damage, make sure that there are no ignition sources nearby and keep the room well ventilated.
- Do not stand on the plinth, drawers or doors or use them to support anything else.
- This appliance can be used by children of 8 years old and over, and also by persons with restricted physical, sensory or mental capacity or lack of experience and knowledge, if they are supervised or have been instructed on safe use of the appliance and understand the resulting risks. Children must not be allowed to play with the appliance. Cleaning and user maintenance must not be carried out by children without supervision.
- Avoid prolonged skin contact with cold surfaces or chilled/frozen food. This could cause pain, numbness and frostbite. In the case of prolonged skin contact, protective measures should be taken, e.g. gloves should be worn.
- Do not consume food which has been stored for too long, as it could cause food poisoning.
- Do not store explosives or sprays using combustible propellants such as butane, propane, pentane, etc. in the appliance. Electrical components might cause leaking gas to ignite. You may identify such sprays by the printed contents or a flame symbol.
- If you have a lockable appliance, do not keep the key near the appliance or within reach of children.
- The appliance is designed for use in enclosed areas. Do not operate the appliance outdoors or in areas where it is exposed to water or damp conditions.
- The LED light strip illuminates the interior of the appliance. It is not suitable for lighting a room.
- When transporting or operating the appliance at an altitude of more than 1500 m above sea level, the glass pane in the door can break due to the reduction in air pressure. Broken fragments are sharp-edged and can cause serious injury.
- Repairs and other work on the appliance may only be carried out with the mains plug visibly disconnected.

## WARNING

Do not use mechanical devices or other means to speed up defrosting other than those recommended by the manufacturer.

## WARNING

The power cable must not be damaged while setting up the appliance.

## WARNING

This appliance contains a UVC bulb. Do not look into the light source.

## WARNING

Do not use electrical devices inside the appliance.

## WARNING

Multiple socket outlets/distribution strips and other electronic devices (e.g. halogen transformers) must not be placed and operated at the rear of the appliance.

## WARNING

Do not close ventilation openings in the appliance housing or integration installation housing.

## WARNING

Do not damage the refrigerant circuit.

## WARNING

Risk of injury due to electric shock! There are current-carrying components under the cover. LED interior lighting may only be replaced or repaired by customer service or specially trained personnel.

## WARNING

Danger of injury from LED lamp. If the cover is defective: do not look directly into the illumination with optical lenses from close proximity. The eyes can be injured.



This symbol is shown on the compressor and indicates the danger of flammable substances.

## Climate rating

The climate rating indicates the ambient temperature at which the appliance may be operated in order to achieve full cooling capacity.

- The climate rating is indicated on the type plate.
- The position of the type plate is shown in the section entitled **Description of the appliance** (page 24).

Rating	Max. ambient temperature	Max. relative humidity
N	32 °C	50 %

The minimum ambient temperature at the installation site is 10 °C.

**Do not operate the appliance outside the specified ambient temperature range!**

## Saving Energy

- Always ensure good ventilation. Do not cover ventilation openings or grill.
- Always keep fan louvres clear.
- Do not place appliance in areas of direct sunlight or next to a stove, heater or similar object.
- The energy consumption depends on the installation conditions, e.g. on the ambient temperature.
- Keep the time the appliance is open to a minimum.

## Electrical Safety

Operate the device **only** with alternating current (AC).

- The permissible voltage and frequency is indicated on the type plate. The position of the type plate is indicated in the chapter **Description of the Appliance** (page 24).
- The socket outlet must be properly grounded and electrically fused.
- The trigger current of the fuse must be between 10 A and 16 A.
- The socket outlet must not be located behind the appliance and must be easily accessible.
- Do not connect the appliance via extension cables or distribution sockets.
- Do not use stand-alone inverters (conversion of direct current to alternating current/ three-phase-current) or energy-saving plugs. Risk of damage to the electronic control system!

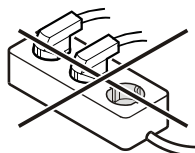

## Disposal notes

The appliance contains reusable materials and should be disposed of properly - not simply with unsorted household refuse. Appliances which are no longer needed must be disposed of in a professional and appropriate way, in accordance with the current local regulations and laws.



When disposing of the appliance, ensure that the refrigerant circuit is not damaged to prevent uncontrolled escape of the refrigerant it contains (data on type plate) and oil.

- Disable the appliance
- Pull out the mains plug
- Cut through the connection cable



**WARNING**

**Danger of suffocation due to packing material and plastic film! Do not allow children to play with packaging material. Take the packaging material to an official collection point.**

## Range of Appliance Use

*The unit is only suitable for the cooling of meat or food in a home or household-like and commercial environment.*

All other types of use are not permitted. The unit is not suitable for the storing and cooling of medicines, blood plasma, laboratory preparations or similar - Medical Devices Directive 2007 /47 / EC with regards to the underlying materials and products. Any misuse of the appliance may result in damage to the stored goods or spoilage. Furthermore, the appliance is not suitable for use in hazardous areas, outdoors or in areas where it is exposed to water or damp conditions.

The appliance complies with the relevant safety regulations and EU directives 2006/42/EG, 2014/30/EU, 2011/65/EU.

## Noise emission

The noise level during operation of the unit is below 49 dB(A) (sound power rel. to 1 pW).

# QUICK STARTER TIPS

---

*The quick starter tips do not replace the elaborate operation instructions, warning and danger notes in the other chapters of this manual.*

1. Clean the inside of the DRY AGER®.  
**Tip:** DRY AGER® SPECIAL CLEANER, item no. Z33145

---
2. If ordered: unpack the salt blocks and remove the foil. Put the salt blocks in the stainless steel tray and place the tray in the middle at the bottom of the inner container. Please check every 2 - 3 days if there is any remaining water on the salt blocks, if so, please remove the water.

---
3. Plug in the device in a 220-240 V socket.

---
4. The temperature and humidity are already set to 1,5 °C and 82% humidity which are the perfect settings for dry aging beef & pork.

---
5. The meat for dry aging must be fresh, best at maximum 5 days after slaughtering. Also vacuum matured meat can be aged for a maximum of about 14 days.  
**Tip for dry aging beef:** Use a saddle from a heifer with good fat cover and marbling.

---
6. Hang the full saddle on the chain suspensions of your DRY AGER VISION 360° Premium or put the individual cuts on the included in the scope of delivery rack inserts.

---
7. Load capacity with chain suspension (hanging):  
Maximum 4 saddles of meat of up to 20-22 kg each.

---
8. Load capacity with the 3 standard grate supports:  
Maximum 90 kg pieces or cuts (additional grate supports can be ordered if required). Use meat with good fat cover and if possible on the bone.

---
9. Always wear protective gloves when coming into contact with the meat. Do not touch the meat without wearing protective gloves!

---
10. Ideal dry aging times are 21 - 28 days, but a dry aging period of more than 4 weeks is also possible, which makes the meat taste even more intense.

---
11. **The UVC lamp must be replaced annually.** A maintenance message appears in the display before the lifetime expires (see **Maintenance**, page 31).

---

## Dimensions (mm)

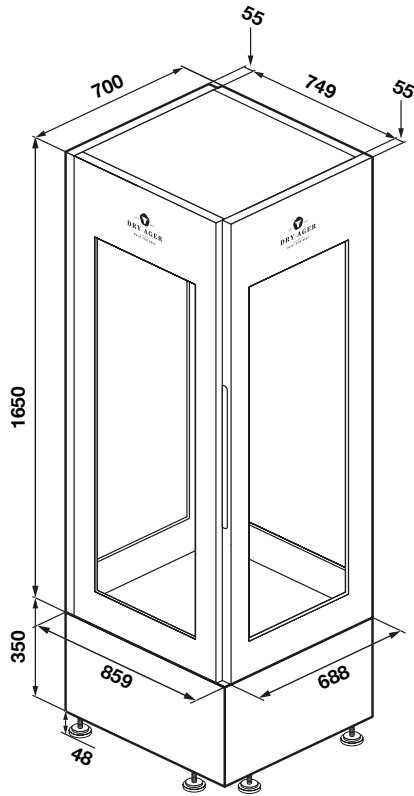

## Integrated systems

### Humicontrol®

Electronic humidity control from 60 % to 90 % (for this system there is no water connection or water container necessary).

### DX Airreg®

Optimum air flow, fresh air activated carbon filter and UVC disinfection

### DX Led interior light

The light spectrum does not contain any ultraviolet radiation, the result is a minimum of heat generated and and no effect on the core food temperature.

### Automatic defrosting, automatic evaporation of condensation water

### Optical and acoustic alarm signal

### 2 lockable doors

### Magnetic door seal

## Description of the Appliance

Front view



Rear view

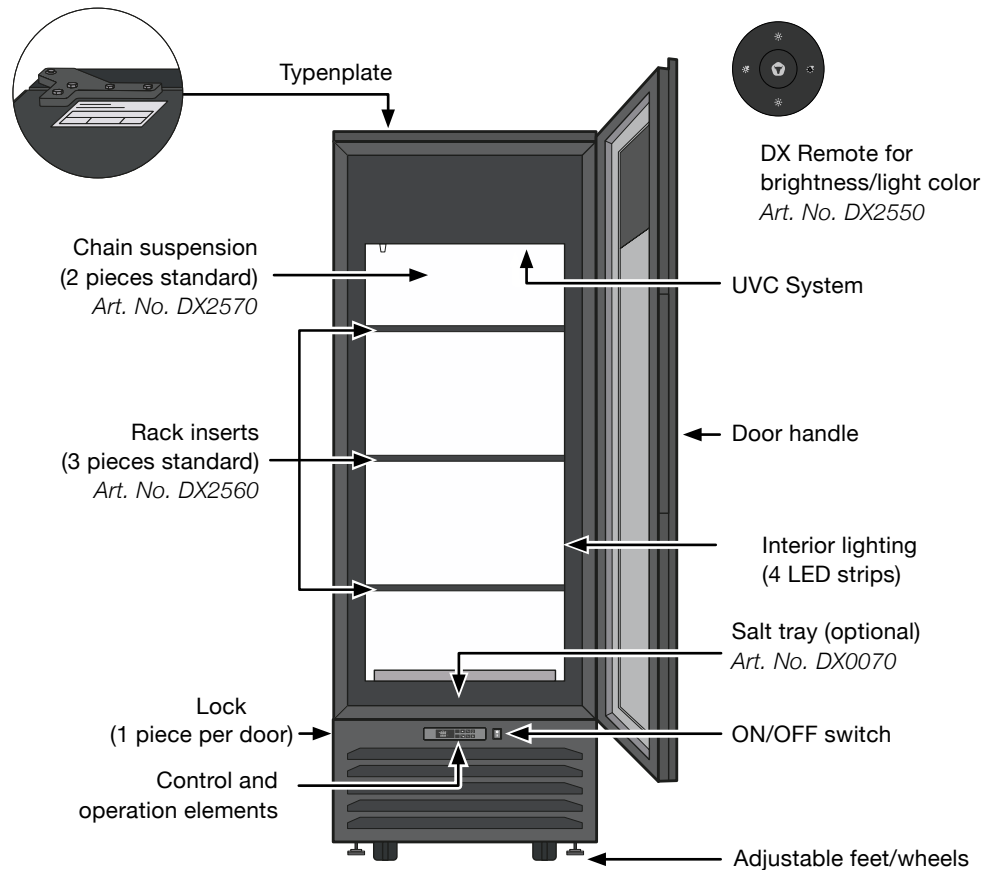

## Instruction for unpacking



**Scan QR Code:** Scan the code to access the complete instructions for unpacking your display cabinet.

## Setting up the appliance

- Avoid locations in direct sunlight, next to stove, radiator and similar.
- The floor at the location should be horizontal and level. Level out any unevenness using the levelling feet.
- **Do not cover ventilation openings or grill.**
- According to the EN 378 standard, the room where your appliance is installed must have a volume of 1 m<sup>3</sup> per 8 g of refrigerant charge R 600a so that no ignitable gas-air mixture can form in the room where the appliance is installed in the event of a leak in the refrigerant circuit. The refrigerant quantity is indicated on the type plate inside the unit.
- Place the unit in its final position at the installation site. Unscrew the 4 leveling foot at the lower hinge angle until they make contact with the floor and use a spirit level to align the housing, then turn them an additional 90°.

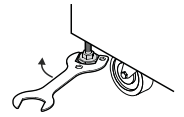
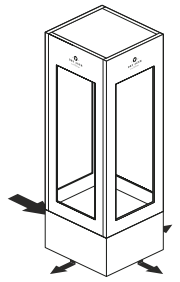

## Preparing the device

### 1. Clean the device and the accessories.

See section **Cleaning Instructions**, page 30.

### 2. Insert chain suspension

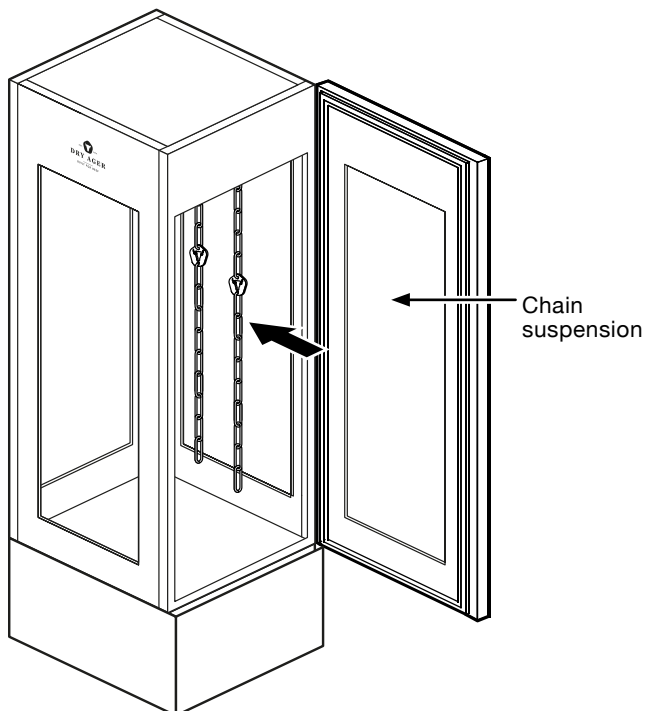

### 3. Insert rack inserts and salt tray

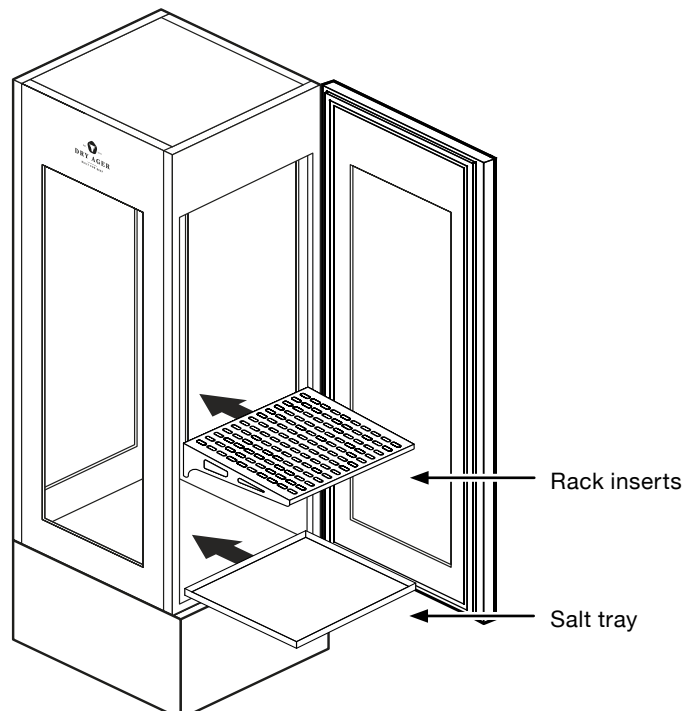







# Operating the Appliance



## Overview of Control Panel



### Controller Keys





-  Increases the displayed value. To turn On / Off the UVC disinfection, press the button for a minimum of 5 sec.
-  Decreases the displayed value
-  View / change the temperature setting.
-  View / change the humidity setting. Select or confirm a parameter during programming.
-  On / Off Button for interior lighting
-  Power On / Off switch

### Controller Key Combinations

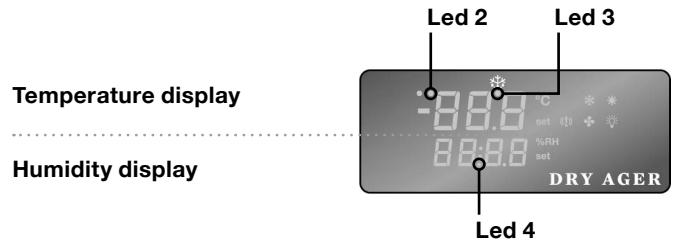
-  Lock and unlock keypad
-  Enter controller configuration menu

## Controller Display and Symbols



Led/Symbol	Mode	Function
Led 4	On	Standby, decimal point
°C	On	°C temperature unit
	On	Cooling
	Flashing	Delay cooling
Led 3 	On	Defrost active
	On	Heating active
set	Flashing	Temperature setpoint (temperature display) / relative humidity setpoint (humidity display)
((!))	On	Acoustic alarm
	On	Fans running
%RH	ON	Relative humidity % unit
Led 2	ON	UVC disinfection active



## Starting the Operation

### 1. Electrical connection

Carefully read section **Electrical Safety** (page 22), before connecting the appliance to the mains socket.

### 2. Switching the appliance ON

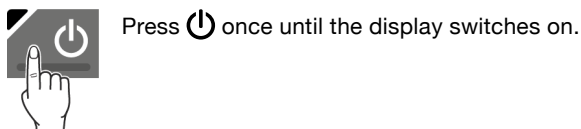

### 3. Turning the interior light ON/OFF (optional)

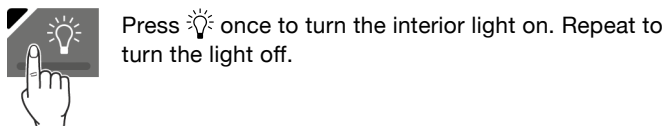

#### Interior Light

The interior of the device is illuminated by four LED light strips positioned at each corner.

The LED lighting corresponds to the risk group RG2.

### IMPORTANT

*The light cover may only be removed by customer service staff.*



**WARNING!**

**If the cover is removed, do not look directly at the light through optical lenses from close distance. This can damage your eyes.**

### 4. Turning the UVC disinfection ON

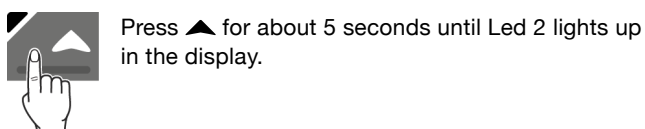

### IMPORTANT

*The UVC disinfection needs to be switched on while dry aging.*

### 5. Choosing temperature & humidity setpoint

The recommended temperature and humidity settings for dry aging depend on the food.

For **dry aging beef** and **pork** we recommend **1,5°C** and **82%** relative humidity.

For **post-maturing ham** and **salami** we recommend **8°C** and **75% RH**.

### 6. Setting temperature

- 
1. Press **set temp.** key: The temperature set value is displayed and flashing.
  2. The **▲** and **▼** arrow keys can be used to change the set value.
  3. To confirm the set value, press **set temp.** key. The temperature display now indicates the actual temperature value.

### 7. Setting humidity

- 
1. Press **set %RH** key: The relative humidity set value is displayed and flashing.
  2. The **▲** and **▼** arrow keys can be used to change the set value.
  3. To confirm the set value, press **set %RH** key. The humidity display now indicates the actual humidity value.

### 8. Locking and unlocking keypad (optional)

The keypad of the controller can be locked/unlocked as follows:

- 
- Lock**
- Press **▼** and **▲** and hold together for a minimum of 3 seconds. 'Pof' appears in the display for a few seconds.

- 
- Unlock**
- Press **▼** and **▲** hold the two keys for a minimum of 3 seconds. 'Pon' appears in the display for a few seconds.

### 9. Locking and unlocking door (optional)

The lock in the appliance door is equipped with a safety mechanism.

#### Locking the appliance:

- Insert the key as shown by arrow 1
- Turn the key through 180°.

To unlock the device, repeat the same procedure

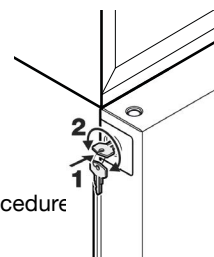

**WARNING!**

**Risk of child entrapment and suffocation due to locked appliance doors. Keep the key in a safe place out of reach of children and not in the vicinity of the appliance.**

## Loading the Device with Food

### 1. Select food

#### IMPORTANT

*Only use food with a maintained cold chain that was handled under good hygienic conditions.*

Some hints for suitable meat:

- Use fresh meat on the bone at maximum 5 days after slaughtering or max. 2 weeks vacuum matured meat (remove foil for dry aging).
- Dry age individual cuts or half saddles of meat on the bone.
- To minimize the weight loss during dry aging, use meat with a thick enough protective layer of fat.
- Recommendation for dry aging beef: saddle from a heifer with good fat cover and marbling.

### 2. Wait for temperature setpoint to be reached

#### IMPORTANT

*Before loading the appliance with food wait for the temperature setpoint to be reached.*

- Note that for the humidity regulation to function properly, the appliance needs to be loaded with food.

### 3. Fill the device

#### IMPORTANT

*When using frozen meat, defrost before putting inside the appliance.*

*Wear clean protection cloth (gloves, etc.) when handling food.*

*For optimal dry aging conditions, air circulation around the food is necessary: prevent mutual contact and contact with the inner container.*

### Option 1: position food lying down

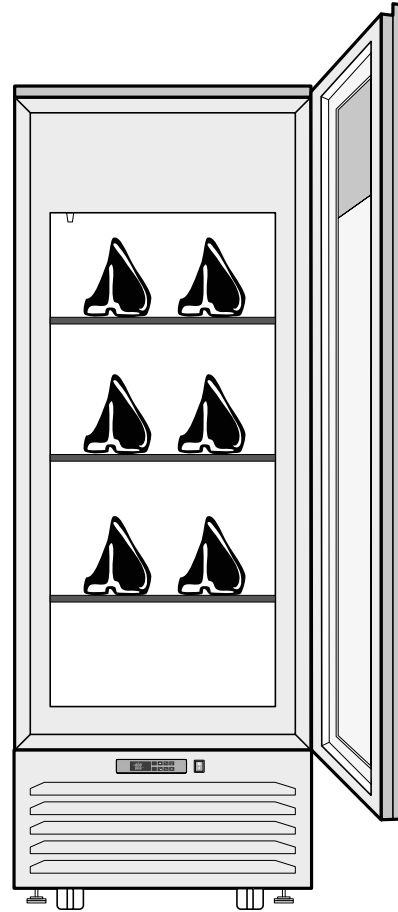

Position the food as shown in the drawing: prevent mutual contact and contact with the inner container.

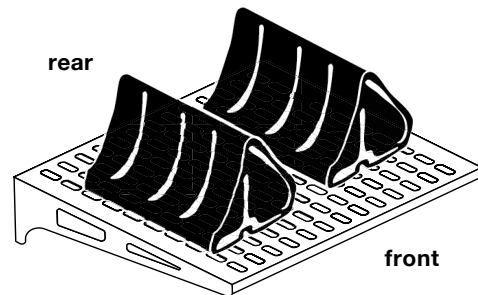

## Option 2: position food hanging

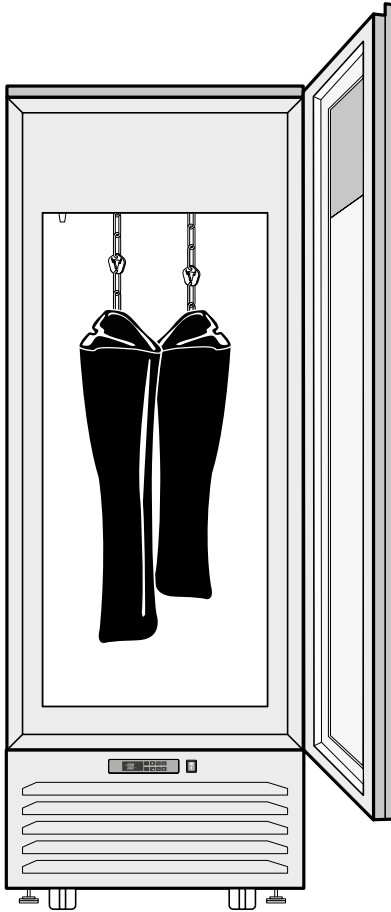

## 4. Consider aging time

The optimal aging time depends on many parameters. Typical aging times, which can be considered as a rough reference, are as follows:

**Fresh meat of beef:** ~ 21-28 days

**Fresh meat of pork:** ~ 14-21 days

**Vacuum packed meat** (remove foil before aging):  
up to ~ 14-18 days

### During Device Operation

#### IMPORTANT

*To sustain the desired climate condition inside the appliance, ensure that the mains power is not interrupted for a prolonged time.*



*Clean the device regularly (see section **Cleaning Instructions**, page 30).*

*Check regularly dry aging food. If you observe mold, an unusual smell (e.g. pungent, putrid) or other potential contamination of the food, dispose it in accordance with your local rules and regulations. Then clean the appliance thoroughly according to section **Cleaning Instructions** (page 30).*

### Shutting Appliance down

After finishing dry aging of goods inside the appliance, prior to cleaning the appliance or for other reason, it can be switched off as follows:



If the appliance is to be switched off for a longer period of time, switch it off at the on/off switch  and disconnect the mains plug or press  once until 'OFF' is displayed and Led 4 lights up. The appliance is now in a standby mode with the compressor turned off.



If the appliance is to be turned off for any length of time, switch it off and disconnect the plug or switch off the circuit breaker / unscrew the fuse. Clean the appliance and leave one of the doors open in order to avoid unpleasant smells.

# Cleaning Instructions



## WARNING!

**Before cleaning always switch off the appliance. Pull out the mains plug or turn off the circuit breaker / unscrew the fuse.**

**To avoid injury or damage, do not use steam cleaning equipment to clean the appliance.**

### IMPORTANT

*Do not use abrasive sponges. Do not use abrasive cleaners containing acidic or chemical solvents. First, test the cleaner on a small area in a place not obviously visible before cleaning the full unit.*

***Do not wipe glass and stainless steel surfaces with dirty wiping clothes, otherwise unsightly rust stains or scratches may occur there.***

*Make sure that no detergent or cleaning water penetrates into the electrical parts and behind the stainless steel ceiling plate.. Do not use a sponge or cloth that is overly wet.*

*Do not damage or remove the type plate on the top of the appliance. It is important for customer service and any warranty claim.*

## Frequency of the cleaning procedure

Regularly clean the interior and outside of the appliance and the accessories by following the cleaning steps 1.-4. below.

### 1. Preparation for the cleaning procedure

- Wear clean protection gloves.
- Remove all goods from inside the appliance and store them in a cool place temporarily.
- Switch the appliance off. Then disconnect the power cord or turn off the circuit breaker / unscrew the fuse.
- Remove all accessories such as chain suspension, rack inserts and the tray from the appliance.

### 2. Cleaning the accessories

- Clean the chain suspension, rack inserts and the tray with warm water and a suitable detergent such as the DRY AGER® SPECIAL CLEANER.
- Clean other accessories according to the cleaning instructions specified in the respective manuals.

### 3. Cleaning the appliance interior

- Use a moist (lukewarm water + suitable detergent such as the DRY AGER® SPECIAL CLEANER) soft cloth or sponge to clean the inside of the appliance.
- Thoroughly dry all parts with a soft cloth.
- Repeat the cleaning procedure if necessary.

### 4. Cleaning the outside of the appliance

- Clean the door surface and outer walls with a clean and soft cloth. If necessary, a good-quality glass cleaner can be used to clean the corresponding surfaces.

## Troubleshooting

### Malfunctions

You may be able to rectify the following faults by checking the possible causes yourself.

#### • Appliance does not function

- Is the appliance switched on?
- Is the plug correctly fitted in the mains socket?
- Is the fuse intact / circuit breaker turned on?

#### • Loud running noise

- Is the appliance set up firmly on the floor?
- Does the appliance cause nearby items of furniture or objects to vibrate? Please note that noises caused by the refrigerant circuit cannot be avoided.

#### • The displayed temperature is not low enough

- Is the temperature setting correct (see section **Setting temperature**, page 27)?
- Mount a separate thermometer inside the appliance to check the temperature displayed by the appliance.
- Is the ventilation system working properly?
- Is the appliance set up too close to a heat source?

If none of the malfunctions apply and you cannot rectify the fault yourself contact the customer service department (see section **Customer Service**, page 31).

## Error Messages

The error messages in the following table are indicated in the display. They are accompanied by an acoustic alarm, which can be acknowledged and switched off by pressing any key at the control keypad.

Message	Reasons	Effect on appliance
P1	Air temperature sensor error	Cooling and heating are turned off.
P2	Evaporator temperature sensor failure	Defrost in fixed time intervals. The display alternately indicates the error message and the temperature inside the appliance.
P3	Humidity sensor error	Humidity control is inactive.
HA	High temperature alarm	regulation unaffected
LA	Low temperature alarm	regulation unaffected
HHA	Moisture-HIGH alarm	regulation unaffected
LHA	Moisture-LOW alarm	regulation unaffected

### Action

Contact the customer service department (see section **Customer Service**, page 31).

Message	Reasons	Effect on appliance
dA	Door alarm: Door open for a prolonged time	regulation unaffected

### Action

The message disappears once the door is closed.

Message	Reasons	Effect on appliance
UCC	Lifetime of UVC-bulb reached	regulation unaffected

### Action

see section **Maintenance** (page 13).

## Maintenance

### UVC

UV lamp ratings

Type: HNS 5W 2G7 DX, Lamp power: 5W, Lamp voltage: 24V  
Initial UVC irradiance > 0.16 W/m<sup>2</sup> @ 1m

The UVC bulb needs to be changed annually or once the appliance shows the warning message 'UCC' on the display.

Be sure to adhere to the maintenance guideline. If there isn't sufficient strength of the UVC light, then this means the appliance is not functioning correctly.

### Action

Order only the original DRY AGER® UVC replacement bulb (item no. DX0101) and replace it according to the instruction.

## Customer Service

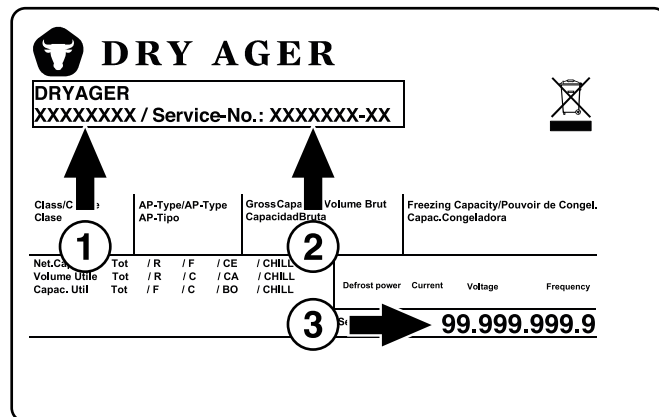

If none of the mentioned causes apply and you are unable to resolve the issue yourself, please contact the nearest customer service center. Provide the model designation (1), service number (2), and serial number (3) from the type plate.

The position of the type plate is shown in section **Description of the Appliance** (page 22).

## Appliance Information

Record this information when the appliance is installed.

(1) Type Designation : \_\_\_\_\_  
 (2) Service Number : \_\_\_\_\_  
 (3) Serial number : \_\_\_\_\_  
 Date of Purchase: \_\_\_\_\_  
 Where Purchased: \_\_\_\_\_

## Disclaimer

The manufacturer accepts no liability for damage to the refrigerated goods, even if the unit is defective within the warranty period. The manufacturer also excludes liability for personal injury caused by improperly stored goods that are subsequently placed on the market.

## Description DX Remote Control

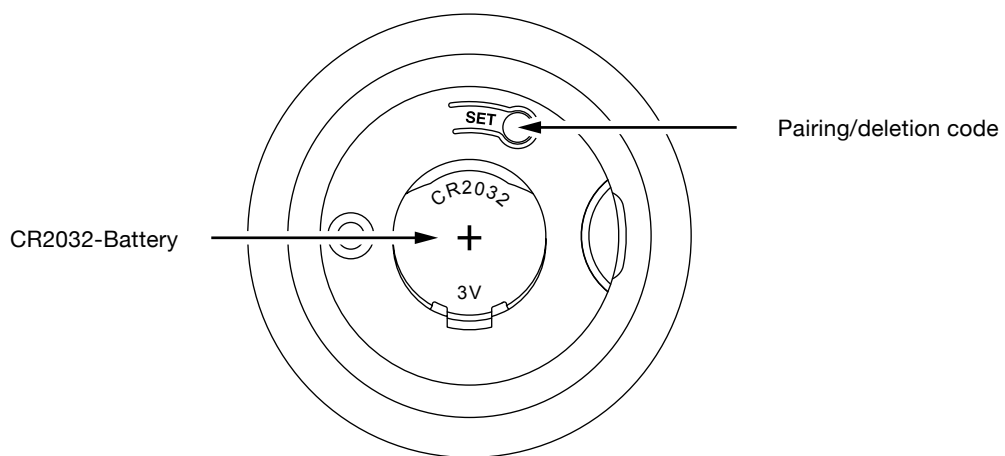
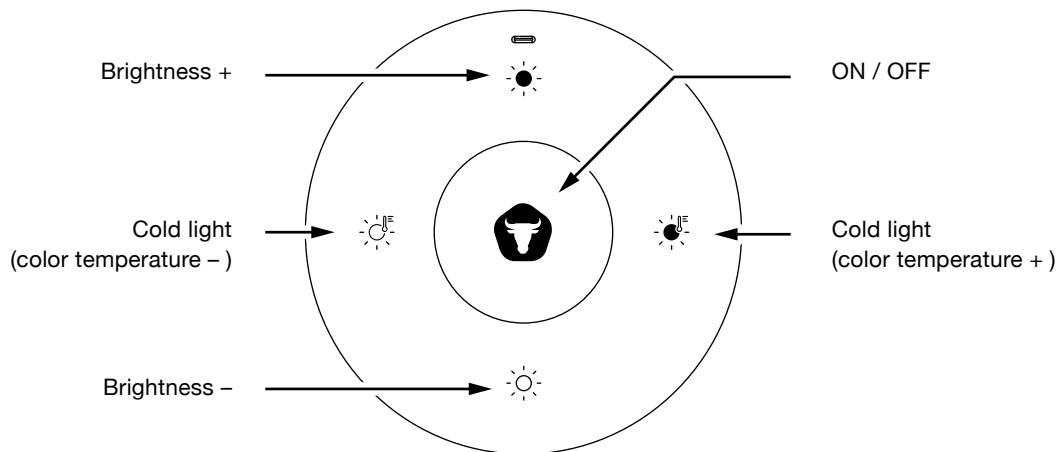

## Install battery DX Remote Control

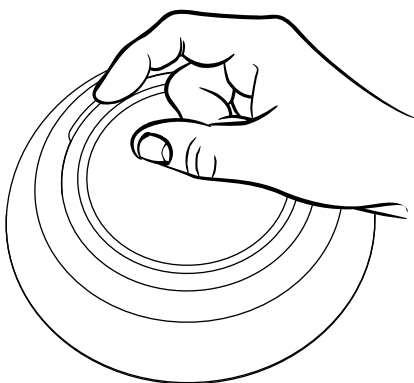

### Step 1

Open the battery cover.

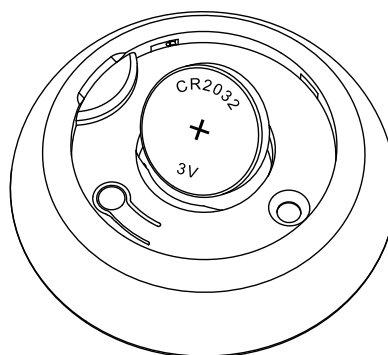

### Step 2

Install the battery as shown in the picture (CR2032 battery).





**DRY AGER**

THE ORIGINAL

---

**Landig + Lava GmbH & Co. KG – DRY AGER Manufaktur**

**Mackstraße 90 – 88348 Bad Saulgau**

**Telefon: +49 7581 90 430 – E-Mail: [info@dry-ager.com](mailto:info@dry-ager.com)**

**Web: [www.dry-ager.com](http://www.dry-ager.com)**



[www.facebook.com/thedryager](http://www.facebook.com/thedryager)



[www.instagram.com/dryager](http://www.instagram.com/dryager)



[www.dry-ager.com](http://www.dry-ager.com)